

Technology All-Season
Manufactured by
elettromedia

POWER
FOR
THE **WAVES**
PURE MARINE
CERTIFIED PRODUCT

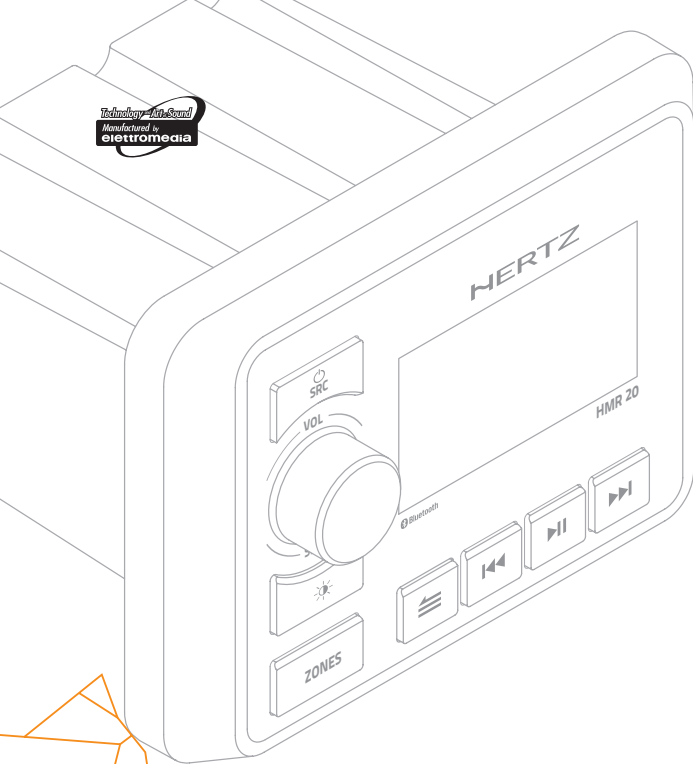

marine

HMR 20

OWNER'S MANUAL

Marine grade source units

Rev. 0.1

Index

2. PRECAUTIONS	4
3. PACKAGING CONTENTS	6
4. DIMENSIONS	6
5. INSTALLATION	7
5.1 Before Starting	7
5.2 Installation Cautions	7
5.3 Mounting hole	7
6. MOUNTING	8
7. CONNECTIONS	9
8. CONTROLS	10
8.1 Front Panel Controls	10
8.2 Name of Buttons and their Functions	10
9. OPERATIONS	11
9.1 Basic Operation	11
▪ Power On/Off	11
▪ Adjusting the volume	11
9.2 System Setting	12
▪ System Setting Menu	12
▪ Display	12
▪ Audio Zone 1	12
▪ Audio Zone 2	13
▪ Low Battery Alert	13
▪ Beep	13
▪ Start Up Volume	13
▪ System	13
9.3 Tuner Operation (AM/FM)	14
▪ Select tuner as Playing source	14
▪ Settings Menu (AM/FM)	14
▪ Preset Station Selection (AM/FM)	14
▪ Seek Tuning (AM/FM)	14
▪ Manual Tune (AM/FM)	15
▪ Save a Preset	15
▪ Select a preset from Favorites list (AM/FM)	15

9.4 DAB Operation (HMB DAB + optional)	16
▪ Select DAB as Playing source	16
▪ DAB Settings Menu (AM/FM)	16
▪ Station Selection	16
▪ Save a Preset	16
▪ Select a preset from Favorites list	17
9.5 USB Mode Operation (when USB device is connected)	17
▪ Select USB as Playing Source	17
▪ Connecting a USB device	17
▪ Select a Track	17
▪ Fast Forward/Fast Rewind	17
▪ Play / Pause	17
▪ USB Setting Menu	18
9.6 AUX In Mode Operation	18
9.7 Bluetooth Operation	19
▪ Select Bluetooth as Playing Source	19
▪ Pair Bluetooth Device	19
▪ Disconnect Current Device	19
▪ Connect Last Device	19
▪ Play / Pause	19
▪ Select a Track	19
10. OPTIONAL ACCESSORIES	20
11. TROUBLESHOOTING	21
11.1 General	21
11.2 USB	21
11.3 Bluetooth	22
11.4 DAB	22
12. TECHNICAL SPECIFICATIONS	23

2. PRECAUTIONS

WARNING: for your safety, while boating, keep the volume to a level at which external sounds can be heard.



1. This unit uses precision parts and components for its operation. In the event of any operating issues, never open the case or disassemble the unit. Contact your Hertz dealer or service center.
2. FCC STATEMENT
 - 2.1 This device complies with Part 15 of the FCC Rules. Operation is subject to the following two conditions:
 - (1) This device may not cause harmful interference.
 - (2) This device must accept any interference received, including interference that may cause undesired operation.
 - 2.2 Changes or modifications not expressly approved by the party responsible for compliance could void the user's authority to operate the equipment.

FCC ID: 2ASUD-HMR20

NOTE: This equipment has been tested and found to comply with the limits for a Class B digital device, pursuant to Part 15 of the FCC Rules. These limits are designed to provide reasonable protection against harmful interference in a residential installation. This equipment generates, uses and can radiate radio frequency energy and, if not installed and used in accordance with the instructions, may cause harmful interference to radio communications. However, there is no guarantee that interference will not occur in a particular installation. If this equipment does cause harmful interference to radio or television reception, which can be determined by turning the equipment off and on, the user is encouraged to try to correct the interference by one or more of the following measures:

- Reorient or relocate the receiving antenna.
- Increase the separation between the equipment and receiver.
- Connect the equipment into an outlet on a circuit different from that to which the receiver is connected.
- Consult the dealer or an experienced radio/TV technician for help.

FCC Radiation Exposure Statement.

This equipment complied with FCC radiation exposure limits set forth for an uncontrolled environment. This equipment should be installed and operated with minimum distance 20 cm between the unit & your body.

3. The Bluetooth word mark and logos are registered trademarks owned by the Bluetooth SIG, Inc. and any use of such marks by Elettromedia srl is under license. Other trademarks and trade names belong to their respective owners.

4. IC warning
This device complies with Industry Canada's license-exempt RSS standard(s).
Operation is subject to the following two conditions:
 - (1) This device may not cause interference
 - (2) This device must accept any interference, including interference that may cause undesired operation of the device.
 This Class B digital apparatus complies with Canadian ICES-0003.

Le présent appareil est conforme aux CNR d'Industrie Canada applicables aux appareils radio exempts de licence.

L'exploitation est autorisée aux deux conditions suivantes:

- (1) l'appareil ne doit pas produire de brouillage
- (2) l'utilisateur de l'appareil doit accepter tout brouillage radioélectrique subi, même si le brouillage est susceptible d'en compromettre le fonctionnement.

This equipment complies with IC radiation exposure limits set forth for an uncontrolled environment. The antenna should be installed and operated with minimum distance of 20 cm between the radiator and your body.

This transmitter must not be co-located or operating in conjunction with any other antenna or transmitter.

Cet appareil est conforme aux limites d'exposition aux rayonnements de la IC pour un environnement non contrôlé. L'antenne doit être installée de façon à garder une distance minimale de 20 centimètres entre la source de rayonnements et votre corps.

L'émetteur ne doit pas être colocalisé ni fonctionner conjointement avec à autre antenne ou autre émetteur.

WARNING: changes or modifications to this unit not expressly approved by the party responsible for compliance could void the user's authority to operate the equipment.

IC ID: 24882-HMR20

Cleaning the Body

- Use a soft, dry cloth and gently wipe off any dirt or dust.
- For persistent dirt, apply some neutral detergent diluted in water on a soft cloth, wipe off the dirt gently, then wipe again with a dry cloth.
- Do not use benzene, thinner, boat cleaner, etc., as these substances may damage the body or cause the paint to peel. Also, leaving rubber or plastic products in contact with the body for long periods of time may cause stains.

USB Port

- The USB memory sticks must be recognized as "USB" to work properly. Some models may not operate correctly. In the event data is lost or damaged under any condition, Elettromedia srl shall not be liable for any damage. When using the USB memory stick, we recommend that you backup your data (music) to a personal computer before using.
- Data (music) files may be damaged when USB memory sticks are removed while the device is reading data, or by static electricity and/or an electrical surge.
- Connect/disconnect the USB memory stick when it is not accessed.
- Disconnect the USB memory device when not in use.

CAUTIONS ON HANDLING

Protect from high temperatures. Exposure to direct sunlight for an extended period of time can produce very high temperature in your vessel. Cool down the interior before starting playback.

3. PACKAGING CONTENTS

HMR 20

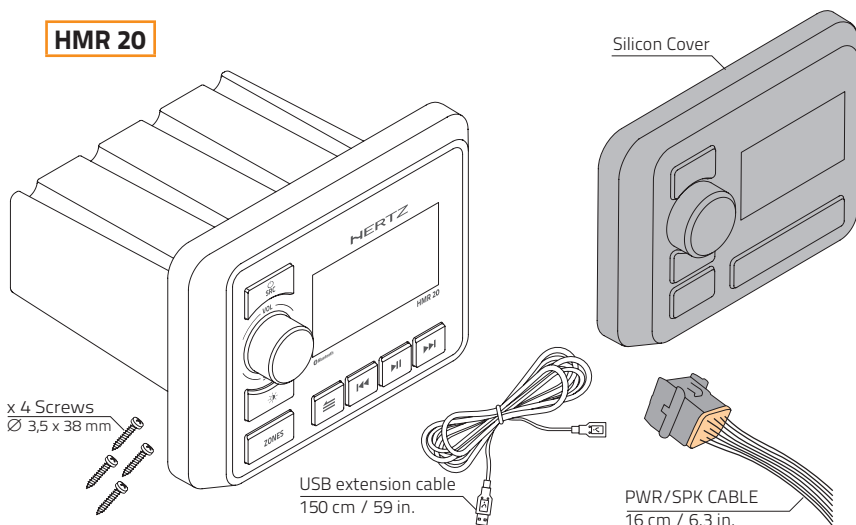

4. DIMENSIONS

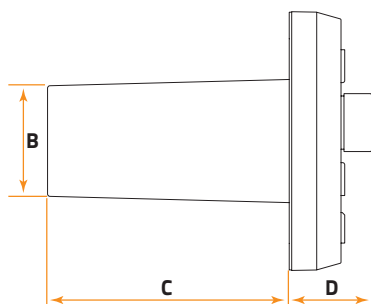
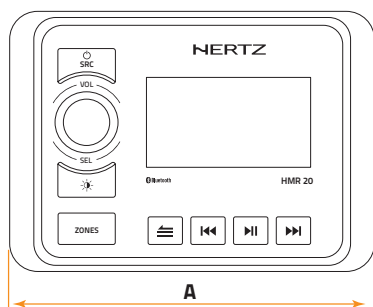

	A	B	C	D	
HMR 20	146	50	98	34	mm
	5.75	1.97	3.86	1.34	in.

5. INSTALLATION

5.1 BEFORE STARTING

1. This set is exclusively for use in vessels with a negative ground 12 V power supply.
2. Read these instructions carefully.
3. Make sure the battery "-" terminal is disconnected before starting. This is to prevent short circuits during installation. (Figure 1)

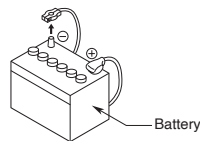
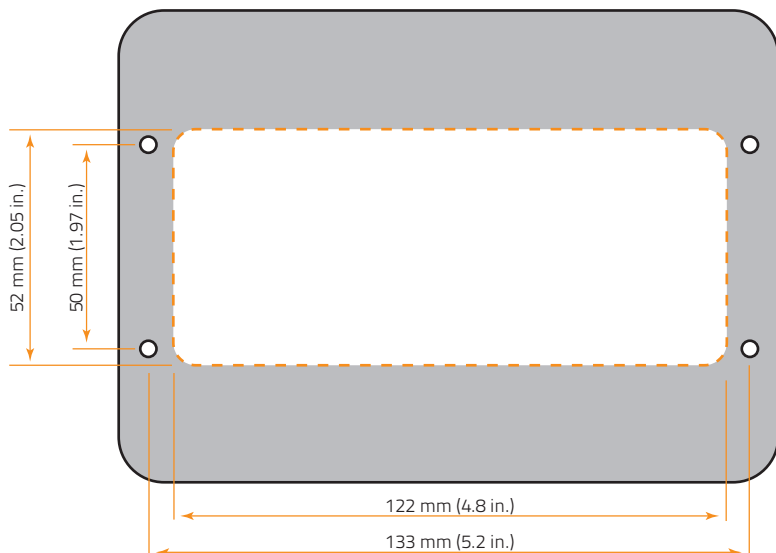

Figure 1

5.2 INSTALLATION CAUTIONS

1. In order to avoid any interference, do not install the tuner module or control unit in the proximity of the engine compartment.
2. The use of unauthorized parts can cause permanent damage to the unit.
3. Always check your wire connections to ensure proper installation before turning on the unit.
4. Consult with your nearest dealer for proper installation or if other accessories are needed to complete the installation.
5. Seek assistance if modifications or drilling holes to your vessel is needed.
6. Do not install the unit where it will be subjected to excessive moisture, dust, dirt, foreign particles or vibration. Areas of high temperature from the engine, direct sunlight, or heat sources should also be avoided.
7. Do not install the unit in a location where it will interfere with the vessel operation, or it will injure the passengers if there is a sudden or emergency stop.

5.3 MOUNTING HOLE



6. MOUNTING

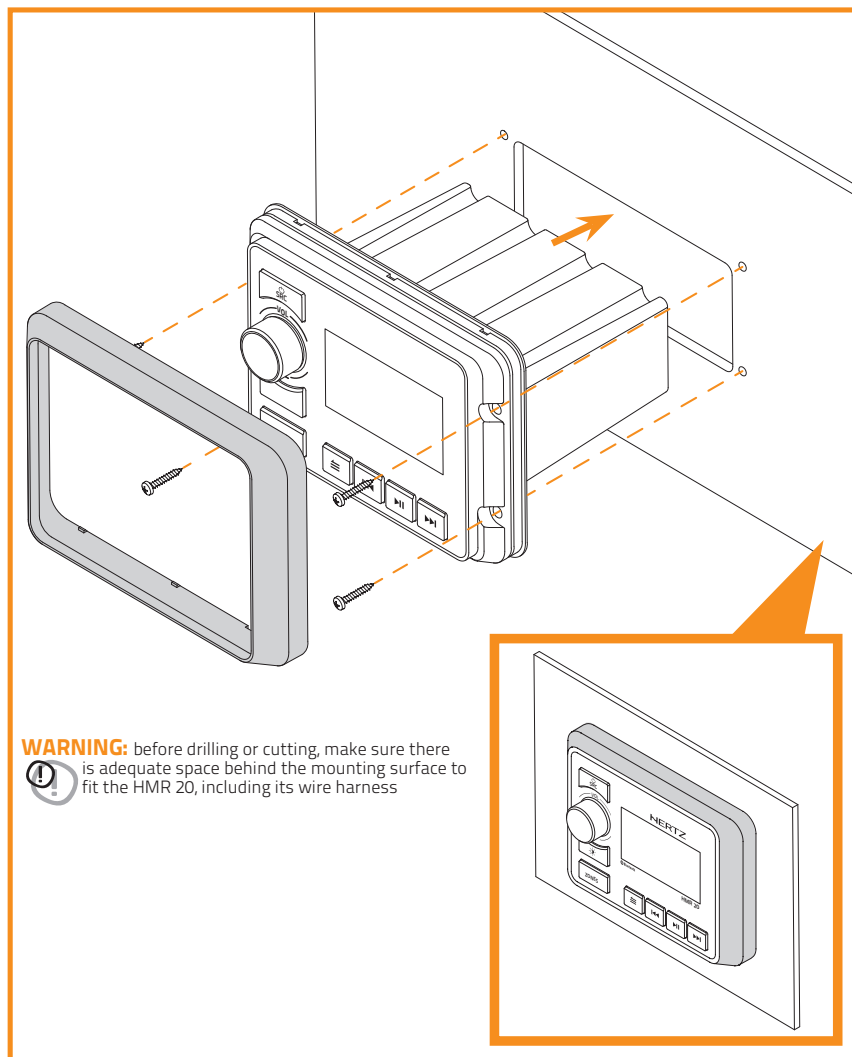

WARNING: before drilling or cutting, make sure there is adequate space behind the mounting surface to fit the HMR 20, including its wire harness



7. CONNECTIONS

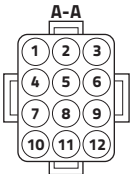
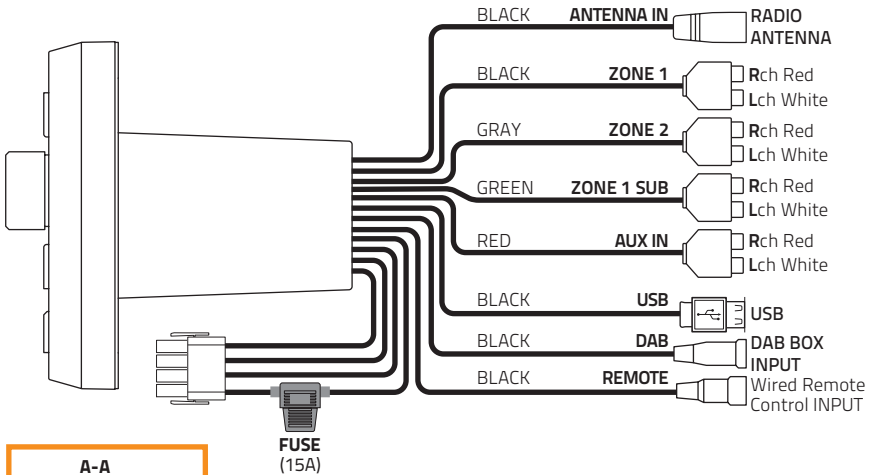

12 pin Harness pin out

No.	Wire color	Description
1	Yellow	Battery (+12V)
2	White/black	Front left -
3	White	Front left +
4	Red	ACC (+12V)
5	Grey/black	Front right -
6	Grey	Front right +
7	Blue	Antenna/Remote out (+12V)
8	Green/black	Rear left -
9	Green	Rear left +
10	Black	GND
11	Violet/black	Rear right -
12	Violet	Rear right +

Note: cable out view

12 PIN HARNESS

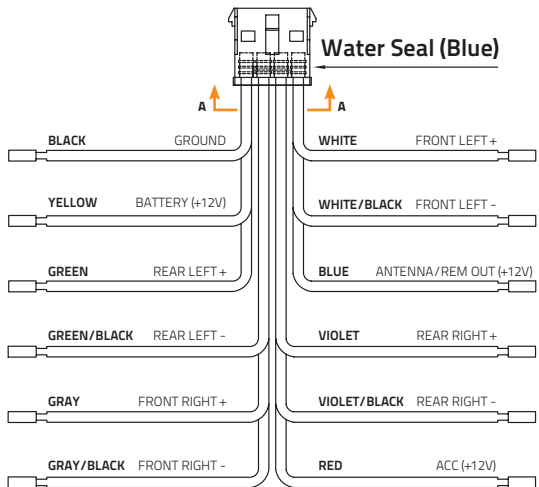



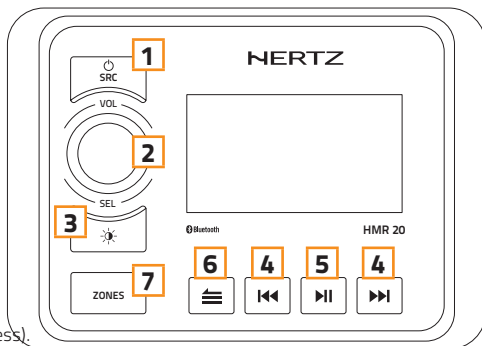

8. CONTROLS

8.1 FRONT PANEL CONTROLS



8.2 NAME OF BUTTONS AND THEIR FUNCTIONS

- 1**  **SRC** Button
 - **Power ON** (short press).
 - **Power OFF** (long press).
 - **Enter to SOURCE SELECTION** (short press).
- 2** **VOL/SEL** Knob
 - **Adjust volume level** (rotate).
 - **Menu navigation and setting adjustments** (rotate/press).
 - **Mute ON/OFF** (short press).
 - **AM/FM/DAB mode:** FAVORITES menu (long press).
- 3**  **DIMMER** Button
 - **Switch between two different brightness values for the display** (short press).
- 4**  **Button**
 - **AM/FM mode:** previous/next preset station (short press).
Seek the previous/next strongest station (long press).
 - **USB mode:** previous/next track (short press).
fast forward/rewind (press and hold).
 - **BT mode:** previous/next track (short press).
 - **DAB mode:** previous/next station (short press).
- 5**  **Button**
 - **AM/FM mode:** enter manual tune (short press).
 - **USB mode:** pause or resume playback (short press).
 - **BT mode:** pause or resume playback (short press).
 - **DAB mode:** scan DAB station (long press).
- 6**  **MENU/BACK** Button
 - **Access system settings** (long press).
 - **Exit from system settings** (long press).
 - **Access active source settings** (short press).
 - **To go back/return to the previous screen** (long press).
- 7** **ZONES** Button
 - **Access AUDIO ZONE LEVEL menu** (short press).
 - **When into AUDIO ZONE LEVEL to switch between Zone1, Zone2, SUB** (short press).

9. OPERATIONS

9.1 BASIC OPERATION

WARNING: when the unit is turned on, starting and stopping the engine with its volume raised to the maximum level may cause hearing damage. Make sure you adjust the volume in advance.

Power On/Off

Note:

- Start the engine before using this unit.
- Be careful about using this unit for a long time without running the engine. If you drain the vessel battery, you may not be able to start the engine and this can reduce the service life of the battery.

1. Start the engine.

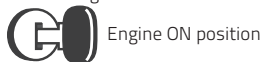

2. Press **⏻ / SCR** to turn the unit ON.
3. Press **⏻ / SCR** to access the SOURCE SELECTION menu.
4. Rotate **VOL/SEL** knob to highlight the desired source, press to select.
(FM>AM>USB>BT>DAB>AUX).

Adjusting the volume

Rotate **VOL/SEL** knob to increase or decrease the volume.

The adjustable range of volume is from 0 to 40.

- The volume of each Zone and Sub relative level are adjustable separately in AUDIO ZONE LEVEL menu.
- Sub volume is linked with Zone1, adjustable relative level range is from -30 to +10

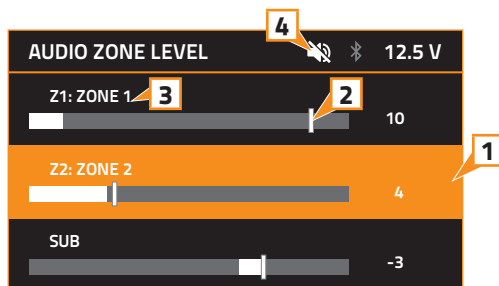

WARNING: while boating, keep the volume at a level at which external sounds can still be heard.
Please be aware of the volume levels in residential, public areas and local volume level ordinances.

- 1 Selected zone volume level.
- 2 Zone max volume limit.
(adjustable see chapter 9.2)
- 3 Zone name.
(rename option available, see chapter 9.2)
- 4 Mute on.



9.2 SYSTEM SETTING

System Setting Menu

- Long press  to access the system settings menu.
- Rotate **VOL/SEL** knob to highlight one of the available options, press to select.
(DISPLAY>AUDIO ZONE 1>AUDIO ZONE 2>LOW BATTERY ALERT>BEEP>START UP VOLUME>SYSTEM).
- Press  to go back to the previous screen menu.
- Long press  to exit from the system settings menu.

Display

- Rotate **VOL/SEL** knob to highlight one of the available options, press to select.
(DIMMER>DIMMER BRIGHTNESS>BUTTONS BACKLIGHT COLORS, TEXT SCROLLING)

DIMMER

Press **VOL/SEL** knob to enable  or disable  this function.

DIMMER BRIGHTNESS

Press **VOL/SEL** knob to switch between options:

DIMMER ON: rotate **VOL/SEL** to adjust brightness level from 0 to 6 when dimmer is enable.

DIMMER OFF: rotate **VOL/SEL** to adjust brightness level from 0 to 6 when dimmer is disable.

BUTTONS BACKLIGHT COLORS

Rotate **VOL/SEL** knob to highlight one of the available options, press to select
(RED>GREEN>BLUE>WHITE>ORANGE>PURPLE>CAMBRIDGE BLUE>AUTO)

TEXT SCROLLING (enable continuous text scrolling where available)

Rotate **VOL/SEL** knob to enable  or disable  this function.

Audio Zone 1

- Rotate **VOL/SEL** knob to highlight one of the available options, press to select.
(EQ>TONE>ZONE RENAME>MAX VOLUME LIMIT>SUB LOW PASS FILTER)

EQ (Preset Equalizer Setting)

Rotate **VOL/SEL** knob to highlight one of the available options, press to select.
(FLAT>CLASS>ROCK>POP>JAZZ>BEAT)

TONE

Press **VOL/SEL** knob to switch between options:

Bass: rotate **VOL/SEL** knob to adjust the desired Bass level range from -7 to +7

Treble: rotate **VOL/SEL** knob to adjust the desired Treble level range from -7 to +7

Balance: rotate **VOL/SEL** knob to adjust the Balance between the right and left channels from R07 (full right) to L07 (full left).

ZONE RENAME (to select the desired name for this audio zone to make it easier to identify)

Rotate **VOL/SEL** knob to highlight one of the available options, press to select.
(BOW>BRIDGE>COCKPIT>FLY>GALLERY>HELM>SALOON>STATEROOM 1
STATEROOM 2>STATE ROOM 3>STERN>TOWER>TRANSOM>ZONE 1>ZONE 2)

MAX VOLUME LIMIT (to limit the maximum volume output of this zone).

Rotate **VOL/SEL** knob to adjust the desired Volume level from 0 to 40.

SUB LOW-PASS FILTER (to set the subwoofer crossover frequency).

Rotate **VOL/SEL** knob to highlight one of the available options, press to select
(80Hz>120Hz>160Hz).

Audio Zone 2

- Rotate **VOL/SEL** knob to highlight one of the available options, press to select.
(EQ>TONE>ZONE RENAME>MAX VOLUME LIMIT)

EQ (Preset Equalizer Setting)

Rotate **VOL/SEL** knob to highlight one of the available options, press to select.
(FLAT>CLASS>ROCK>POP>JAZZ>BEAT)

TONE

Press **VOL/SEL** knob to switch between options:

Bass: rotate **VOL/SEL** knob to adjust the desired Bass level range from -7 to +7

Treble: rotate **VOL/SEL** knob to adjust the desired Treble level range from -7 to +7

Balance: rotate **VOL/SEL** knob to adjust the Balance between the right and left channels from R07 (full right) to L07 (full left).

ZONE RENAME (to select the desired name for this audio zone to make easier to identify)

Rotate **VOL/SEL** knob to highlight one of the available options, press to select.
(BOW>BRIDGE>COCKPIT>FLY>GALLERY>HELM>SALOON>STATEROOM 1
STATEROOM 2>STATE ROOM 3>STERN>TOWER>TRANSOM>ZONE 1>ZONE 2)

MAX VOLUME LIMIT (to limit the maximum volume output of this zone).

Rotate **VOL/SEL** knob to adjust the desired Volume level limit from 0 to 40.

Low Battery Alert (Notifies of low battery voltage condition)

Press **VOL/SEL** knob to enable  or disable  this function.

Note: this alert notifies when the 12VDC supply voltage drops below 10 volts.

If enabled, the unit will enter Safe Mode and mute the audio output. A warning will also be displayed on-screen with instructions to turn the unit off until normal operating voltage is restored.

Beep

Press **VOL/SEL** knob to enable  or disable  this function.

Start Up Volume

Press **VOL/SEL** knob to switch between options:

Z1:ZONE 1

Rotate **VOL/SEL** knob to adjust the desired start up Volume level from 0 to 40.

Z2:ZONE 2

Rotate **VOL/SEL** knob to adjust the desired start up Volume level from 0 to 40.

System

(FACTORY DEFAULT>SOFTWARE VERSION)

FACTORY DEFAULT

Press **VOL/SEL** knob, then select and press **[YES]** to restore all settings to the factory default values.

SOFTWARE VERSION

Press **VOL/SEL** knob to show the software version information.

9.3 TUNER OPERATION (AM/FM)

Select tuner as Playing Source

1. Press **⏪ / SCR** to access the SOURCE SELECTION menu.
2. Rotate **VOL/SEL** knob to highlight the desired tuner mode, press to select (**FM>AM**)



Settings menu (AM/FM)

- Press **≡** to access the settings menu. (AM/FM).
- Rotate **VOL/SEL** knob to highlight the desired option, press to select. (AM/FM RADIO REGION>AM/FM AUTO STORE).
- Press **≡** to go back to the previous screen or exit the menu.

AM/FM RADIO REGION

Rotate **VOL/SEL** knob to highlight the desired radio region, press to select. (AMERICAN>EUROPE>SOUTH AMERICAN>RUSSIAN).

AM/FM AUTO STORE (only station with sufficient signal strength will be detected and stored in the memory).

FM AUTOSTORE

Press **VOL/SEL** knob to automatically find the available stations and store them into presets (the new station replaces any stations already stored).

AM AUTOSTORE

Press **VOL/SEL** knob to automatically find the available stations and store them into presets (the new station replaces any stations already stored).

Preset station selection (AM/FM)

- Press **⏪** to move to the previous preset.
- Press **⏩** to move to the next preset.

SEEK Tuning (AM/FM)

- Long press **⏪** to SEEK the previous strongest station.
- Long press **⏩** to SEEK the next strongest station.

Manual Tune (AM/FM)

- Press **▶||** to access the manual tuning, the display shows **MANUAL tune** (the system reverts to **AUTO** mode after a few seconds if no button is pressed).
- Press **◀◀** or **▶▶** to manual tune the desired frequency (the system reverts to **AUTO** mode after a few seconds if no button is pressed).

Save a preset (You can save up to 18 of your favorite stations when in FM, or up to 12 when in AM, as presets for a quick access)

- 1) Tune the desired station / frequency
- 2) Long press **VOL/SEL** knob to access into FM FAVORITES screen (FM TUNER), or AM FAVORITES screen (AM TUNER).
- 3) Rotate **VOL/SEL** knob to select the desired preset number.
- 4) Long press **VOL/SEL** knob to store it.

Select a preset from FAVORITES list (AM/FM).

- 1) Long press **VOL/SEL** knob to access the FAVORITES screen (AM/FM).
- 2) Rotate **VOL/SEL** knob to highlight the desired preset, press to select.

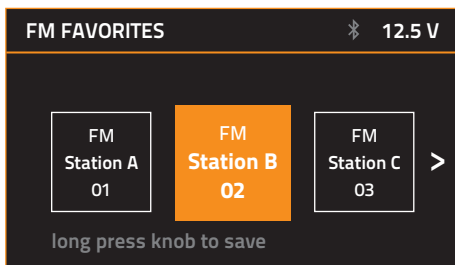

9.4 DAB OPERATION (HMB DAB+ optional)

Select DAB as Playing Source

1. Press **⏻ / SCR** to access the SOURCE SELECTION menu.
2. Rotate **VOL/SEL** knob to highlight **DAB**, press to select.

Remark: for first installation long press **▶▶** to scan for local **DAB** station.

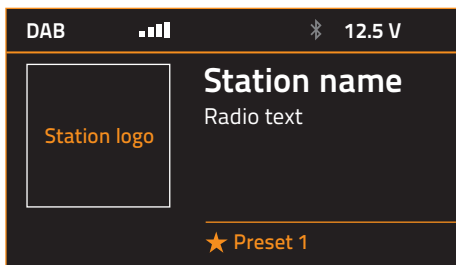

DAB Settings menu

- 1 Press **≡** to enter into DAB settings menu
- 2 Rotate **VOL/SEL** knob to highlight the desired option, press to select. (DAB SCAN>DAB STATION LIST>TA>SLIDESHOW).
- 3 Press **≡** to go back to the previous screen or exit from menu.

DAB SCAN

Press **VOL/SEL** knob to perform a full scan of the available DAB stations.

DAB STATION LIST (contains the list of DAB stations found after DAB scan)

Press **VOL/SEL** knob to select a station from the list:

Remark: the list is empty if a "DAB SCAN" has never been performed.

TA (Traffic announcement)

Rotate **VOL/SEL** knob to enable or disable this function.

SLIDE SHOW (to view information and content)

Rotate **VOL/SEL** knob to enable or disable this function.

Station selection

- Short press **◀◀** to move to the previous station available on the dab station list.
- Short press **▶▶** to move to the next station available on the dab station list.

Save a preset (You can save up to 18 of your favorite stations as presets for a quick access)

- 1 Select the desired station.
- 2 Long press **VOL/SEL** knob to access FAVORITES screen.
- 3 Rotate **VOL/SEL** knob to highlight the desired preset number.
- 4 Long press **VOL/SEL** knob to save it.

Select a preset from Favorites list

- 1 Long press **VOL/SEL** knob to access FAVORITES screen.
- 2 Rotate **VOL/SEL** knob to highlight the desired preset.
- 3 Press **VOL/SEL** knob to select.

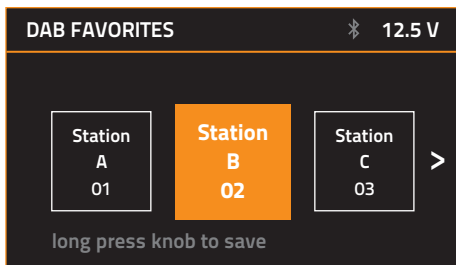

9.5 USB MODE OPERATION (available only when a USB device is connected)

Select USB as Playing Source

1. Press **SCR** to access the SOURCE SELECTION menu.
2. Rotate **VOL/SEL** knob to highlight **USB**, press to select.

Connecting a USB device

- Insert a USB device into the USB port (please check the tech sheet at the end of this manual for details).
- To remove the USB device, you should select another source or turn off the power, in order to avoid damaging the USB device. Then remove the USB device.

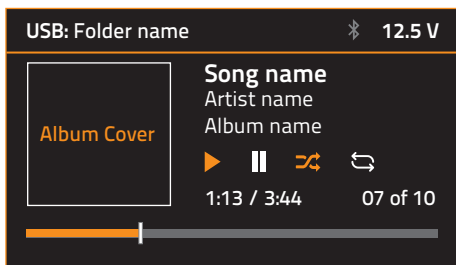

Select a Track

- Press **Next** to move to the next track/song. Press **Previous** to go back to the previous track/song.



Fast Forward/Fast Rewind

- Press and hold **Next** to fast forward through the track/song.
- Press and hold **Previous** to fast rewind through the track/song.

Play / Pause

- Press the **Play/Pause** to pause the track/song that is currently playing, **Play/Pause** lights up.
- Press the **Play/Pause** to resume playing the track/song that has been paused, **Play/Pause** lights up.

USB Setting Menu

- 1 Press  to enter the USB settings menu.
- 2 Rotate **VOL/SEL** knob to the desired option, press to select (**BROWSER>REPEAT>SHUFFLE**).
- 3 Press  to go back to previous screen or exit from the menu.

BROWSER

Use **VOL/SEL** knob and  to browse the USB device content.

Rotate **VOL/SEL** knob to highlight the desired song or folder

Press **VOL/SEL** knob to play the song or access the folder

Press  to exit from the current folder

Press  to exit the USB browsing (only if you are in the USB root)

Remark: the system exits from the USB browsing after a few seconds if no button is pressed.

REPEAT

Press **VOL/SEL** to switch between Repeat options:

REPEAT ALL  logo lights up.

REPEAT ONE  logo lights up.

SHUFFLE

Press **VOL/SEL** knob to enable shuffle  logo light up or disable.

9.6 AUX IN MODE OPERATION

The AUX In RCA inputs in this system are provided to allow playback of sounds and music from external devices connected to this unit.

1. Press /SRC to access SOURCE SELECTION menu.
2. Rotate **VOL/SEL** knob to highlight **AUX**, press to select.

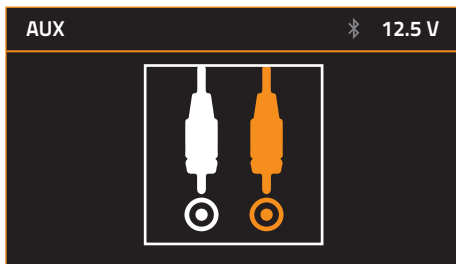

9.7 BLUETOOTH OPERATION

Select Bluetooth as Playing Source

1. Press **⏻ / SCR** to access the SOURCE SELECTION menu.
2. Rotate **VOL/SEL** knob to highlight **BT**, press to select

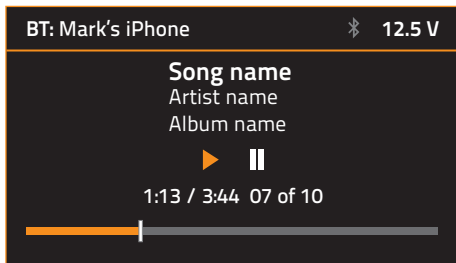

Pair Bluetooth Device

Enable Bluetooth in your streaming device and scan for nearby devices, select HMR 20 from your list of available devices to connect

Disconnect Current Device

- 1 When the device is connected short press **≡** to go into BT Setting.
- 2 Press **VOL/SEL** knob to disconnect the device.

Connect Last Device

- 1 When the device is disconnected short press **≡** to go into BT Setting.
- 2 Press **VOL/SEL** knob to connect the device.

WARNING: please avoid operating your connected mobile phone while audio streaming as this may cause noise or stuttering on the song playback. Audio streaming may or may not resume after telephone interruption as this depends on the mobile phone used.

Play / Pause

- Press **▶||** to pause the track/song that is currently playing.
- Press **▶||** to resume playing the track/song that has been paused.

Select a Track

- Press **◀◀** to move on to the previous track/song.
- Press **▶▶** to go back to the next track/song.

Remark:

Playing order will depend on Bluetooth audio player. When **◀◀** is pressed some A2DP devices will restart the current track depending on the duration of the playback. Some Bluetooth audio players may not allow play / pause synchronization with this unit. Please make sure both the device and the main unit are in the same play / pause status in BT Music mode.

10. OPTIONAL ACCESSORIES



HMC U1 REMOTE CONTROL

Play your favorite song and pump-up the volume while swimming in open water. Thanks to IPX7 certification you can install HMC U1 remote control anywhere on the boat.



HMB DAB+

This module adds DAB+ DIGITAL RADIO capability to Hertz Marine sources. Provided with dedicated antenna.



HMA USB AUX IN

Extension cable water proof 2 mt.



HMA C3.5Y

3.5 jack y cable.



HMA C3.5

3.5 jack extension cable 10 mt.

Optional for HMR 50, HMR 20, HMR 10 D, HMR 10.

11. TROUBLESHOOTING

11.1 GENERAL

Problem	Cause	Remedy
Unit cannot power on.	Unit fuse blown.	Replace with new fuse of correct value.
	Vessel battery fuse blown.	Replace with new fuse of correct value.
No/low audio output.	Incorrect audio output connection.	Check wiring and correct.
	Volume set too low.	Increase volume level.
	Speakers damaged.	Replace speakers.
	Heavily biased volume balance.	Adjust the channel balance to center position.
	Speaker wiring is in contact with metal part of vessel.	Insulate all speaker wiring connections.
Poor sound quality or distortion.	Speaker power rating does not match unit.	Replace speakers.
	Wrong connections.	Check wiring and correct.
	Speaker is shorted.	Check wiring and correct.
Unit resets itself when engine is off.	Incorrect connection between ACC and Battery.	Check wiring and correct.
Auto seek function can not find any stations.	The antenna cable is not connected.	Insert the antenna cable securely.
	The signals are too weak.	Select a station manually.

11.2 USB

Problem	Cause	Remedy
USB device cannot be inserted	The USB device has been inserted incorrectly.	Reverse the connection direction of the USB device and try again.
	The USB connector is broken.	Replace with a new USB device.
USB device is not recognized or USB SOURCE not accessible	The USB device is damaged.	Disconnect the USB device and reconnect. If the device is still not recognized, try replacing it with a different USB device.
	Connectors are loose.	
No sound heard with the display showing "No File".	No MP3 / WMA / WAV* file is stored in the USB device.	Store these files properly in the USB device.
Sound skips or is noisy.	MP3 / WMA / WAV* files are not encoded properly.	Use properly encoded MP3 / WMA / WAV* files

*16bit/44.1kHz only

11.3 BLUETOOTH

Problem	Cause	Remedy
Cannot pair the Bluetooth enabled device with the audio system.	The device does not support the profiles required for the system.	The external BT device is not compatible.
	The Bluetooth function of the device is not enabled.	Refer to the user manual of the device for how to enable the function.
Audio quality is poor after connection with a Bluetooth enabled device.	The Bluetooth reception is poor.	Move the device closer to the audio system or remove any obstacle between the device and the system.

11.4 DAB

Problem	Cause	Remedy
Dab station list empty	Dab scan not performed	Perform a full dab scan (<i>see sec. 9.4</i>)
	The antenna cable is not connected	Connect the antenna cable securely

12 TECHNICAL SPECIFICATIONS

FM TUNER		
Frequency Range	America	87.9 - 107.9 MHz
	Europe	87.5 - 108.0 MHz
	South America	87.5 - 107.9 MHz
	Russia	87.5 - 108.0 MHz
AM TUNER		
Frequency Range	America	530 - 1710 KHz
	Europe	531 - 1620 KHz
	South America	530 - 1710 KHz
	Russia	531 - 1629 KHz
DAB+ Ready (HMD DAB+ optional module)		
Frequency Range	Band 3 174,928 MHz – 239,2MHz	
AUDIO		
Maximum Power Output	50 W x 4 (@ 4 Ohm)	
Speaker impedance	4-8 ohms per channel	
Line Max Output Level @ 0.1 % THD	Zone 1: 4Vrms x 2	
	Zone 2: 4Vrms x 2	
	Sub: 4Vrms x 2	
Controls	Treble,Bass,Balance (adjustable for each separate Zone)	
Sub Low Pass crossover frequency	80Hz,120Hz,160Hz	
AUX Input	1 stereo RCA plugs	
USB		
Interface	2.0 Full Speed	
Maximum Current Output	2 A	
USB Voltage	5.0 V	
Supported Audio Format	MP3,WMA,WAV* (* 16bit/44.1kHz only)	
Maximum MP3/WMA Songs	Max Folder: 256	
	Max File: 999 Max files per folder: 999	
USB Flash Drive	Max Capacity 64 GB	
Compatible Format	FAT/FAT32	
BLUETOOTH		
Specification	Bluetooth Version 5.0 (ID3 tag display)	
Supported Profiles	<ul style="list-style-type: none"> A2DP (Advanced Audio Distribution Profile) AVRCP 1.5 (Audio/Video Remote control profile) SSP (Simple Secure Pairing) 	
	Connection Range	
	Up to 10m (30ft.)	

GENERAL	
Power Supply Voltage	12 V DC (10 to 16 V allowable)
Grounding System	Negative Ground
Operating Temperature Range	-20°C to 70°C (-4°F to 158°F)
IP Protection	IP66 IEC60529
Voltage Gauge	Yes
Over/Low Voltage	Alert
Over Temperature	Protection*
Display Type	3" COLOR TFT IPS (640 x 360 pixels)
SIZE	
Unit Dimensions mm / (in.) W x H x D	146 x 105 x 121 (5.75 x 4.13 x 4.76)
Mounting depth mm/(in.)	99 (3.89)
Mounting Hole size mm/(in.) W x H	122 x 52 (4.8 x 2.05)
WEIGHT	
g/(lb)	830 (1.83)
NOTE: Specifications and design are subject to change without notice for further improvement.	
CEA SPECIFICATIONS	
	Output power @ 4Ω, ≤1% THD+N, 14.4 V: 22 W x 4 RMS

* To avoid an excessive overheating, the unit will enter in Safe Mode and mute the audio output

A warning will also be displayed on-screen with instructions to turn the unit off. Until normal operating temperature is restored.



PART OF **ELETTROMEDIA**

Strada Regina Km 3,500 - Marignano
62018 Potenza Picena (MC) Italy

T +39 0733 870 870 - F +39 0733 870 880

www.elettromedia.it